

## Recessed downlighter EBD 150 SG, EBDT 150 SM for compact fluorescent lamps

The luminaire consists of the reflector housing and the gear tray

**Reflector housing:** Robust mounting ring in die-cast metal with tool-less clamping mechanism, and fixing for the lampholder.

**Gear tray:** Gear tray plate made of galvanized steel, accommodates all electrical components, connector block, cable strain relief and connecting cable with lampholder block. Heat-resistant plastic cover.

### Electrical equipment:

- Ballasts (KVG/VVG) 230V, 50 Hz or electronic ballast (EVG) 220-240V, 0/50-60 Hz.
- Radio interference suppression in accordance with EC directives.
- With KVG/VVG, prepared for parallel power factor correction with accessory 0207700.
- Connector block 5x2.5 mm<sup>2</sup>.

### Mounting:

In addition to the prefitted standard luminaire fixing, special accessory fixing kits such as panel mounting kits, reinforcement plates for metal tiled ceilings, cast concrete housings, plaster ring, inclined mounting kits or semi-recessed mounting kits can be ordered.

For a detailed description of fixing accessories, see pages 498 to 500.

### Decorative accessories:





For detailed descriptions of the decorative trims, see pages 492 to 496.

### Special versions:

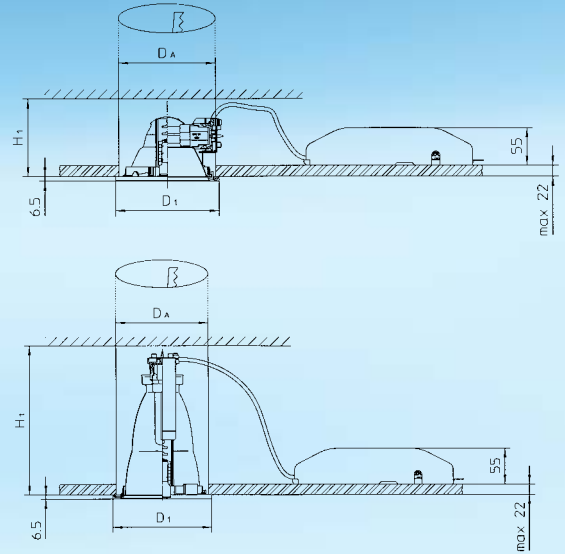
The following special versions are available in response to customer request against a surcharge:

- Prefitted dimmable electronic ballasts.
- Versions for central or integral emergency operation in maintained or non-maintained mode.



Voltage	220 - 240 V
Protection class	IP 20
Approvals	   



### Reflector SG:

Anodised silver "SG"

Parabolic reflector made of specular anodised super-purity aluminium.



### Reflector SM:

Anodised silver "SM"

Parabolic reflector made of anodised super-purity aluminium with satin finish.

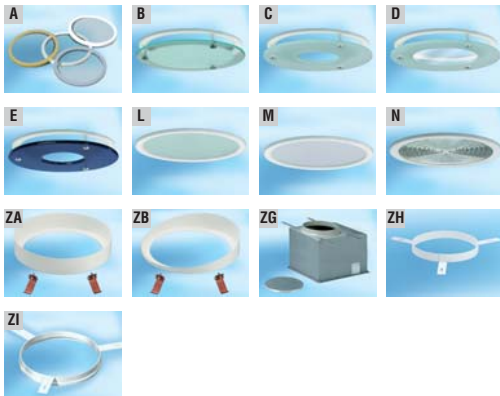

Useable decorative trims	Pr. code for EBD 150	Pr. code for EBDT 150
A DR...W	0202674	0202674
DR...SM	0202674//607	0202674//607
DR...SG	0202674//609	0202674//609
DR...AL	0202674//634	0202674//634
DR...ES	0202674//636	0202674//636
DR...RAL	0202674RAL	0202674RAL
B DG...W	0202682	0202682
C DGS...W	0202691	0202691
D DSG...W	0202700	0202700
E DGFB...W	0202709	0202709
L DGD...W*	0202733	0202733

Useable decorative trims	Pr. code for EBD 150	Pr. code for EBDT 150
M DGOD...W*	0202738	0202738
N DVRP...W*	0202743	0202743
ZA HES EBD/25	0202806	0202806
HES EBD/50	0202807	0202807
ZB SES EBD/10	0202817	0202817
SES EBD/15	0202818	0202818
ZG BET EBD/EBDT	0202825	0202834
ZH EPR EBD	0202837	0202837
ZI EPRD EBD	0202797	0202797

\* In conjunction with these accessories, protection rating IP44 when mounting in sealed ceilings

**Note:** Finish of the visible surface of decorative trims type A:

DR...W, white                      DR...AL, natural aluminium colour,  
 DR...SM, matt silver            DR...ES, natural stainless steel colour,  
 DR...SG, specular silver        DR...RAL, painted in accordance with the RAL colour chart.

For a description of decorative trims / accessories, see pages 492 to 500.

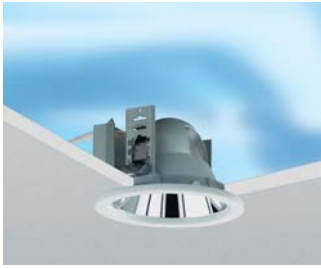

**EBD 150/... SG**

Standard version recessed downlighter with reflector **SG** and white plastic cover ring (PA).

**Note:**

Recessed downlighters are supplied as standard with the reflector **SG**.

Luminaires fitted with reflectors **SM** are special order models. The ordering data can be simply derived from the standard type.

**Example:**

Standard types with reflector **SG**

**Prod. code x30xxxx**

Special order types with reflector **SM**

**Prod. code x30xxxx//607**

Other cover rings in accordance with the table item **A** are available on request or as retrofit accessories.

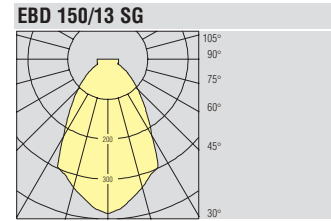

**Quick calculation table (Reflectances: 70/ 50/ 20 )**

E in lux	MH in m	1 x TC-D 13W/21 / 900 lm							
		Room area in m²							
		20	30	40	50	70	80	90	100
300	1,65	21	30	38	46	63	71	78	86
	2,15	24	32	41	49	66	74	83	91
	2,65	26	35	44	52	70	78	87	95
500	1,65	35	49	63	77	104	117	130	143
	2,15	39	53	68	82	110	124	138	151
	2,65	43	58	73	87	116	130	144	158

Maintenance factor: 0,67

►► Lighting data: [www.ridi.de](http://www.ridi.de)

Model	Lamps	Lampholder	Dimensions [mm]			Weight [kg]	Prod. code with KVG	Prod. code with EVG
			D <sub>1</sub>	H <sub>1</sub>	D <sub>A</sub>			
EBD 150/13 SG	1xTC-D/10,13W	G24d-1	150	105	135-140	1,8	1300107	
EBD 150/13 SG-EVG	1xTC-DEL/10,13W	G24q-1	150	105	135-140	1,6		1320107



**EBDT 150/... SM**

Standard version recessed downlighter with reflector **SM** and white plastic cover ring (PA).

**Note:**

Recessed downlighters are supplied as standard with the reflector **SM**.

Luminaires fitted with reflectors **SG** are special order models. The ordering data can be simply derived from the standard type.

**Example:**

Standard types with reflector **SM**

**Prod. code x30xxxx**

Special order types with reflector **SG**

**Prod. code x30xxxx//609**

Other cover rings in accordance with the table item **A** are available on request or as retrofit accessories.

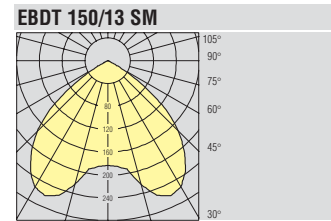

**Quick calculation table (Reflectances: 70/ 50/ 20 )**

E in lux	MH in m	1 x TC-D/E 13W/840 / 900 lm							
		Room area in m²							
		20	30	40	50	70	80	90	100
300	1,65	21	30	39	47	63	71	79	87
	2,15	24	33	41	50	67	75	84	92
	2,65	27	36	45	53	70	79	88	96
500	1,65	35	50	64	78	105	118	132	145
	2,15	40	54	69	83	111	125	139	153
	2,65	45	60	75	88	117	132	146	160

Maintenance factor: 0,67

►► Lighting data: [www.ridi.de](http://www.ridi.de)

Model	Lamps	Lampholder	Dimensions [mm]			Weight [kg]	Prod. code with KVG	Prod. code with VVG	Prod. code with EVG
			D <sub>1</sub>	H <sub>1</sub>	D <sub>A</sub>				
EBDT 150/13 SM	1xTC-D/10,13W	G24d-1	150	225	135-140	1,8	1300609		
EBDT 150/18 SM	1xTC-D/T/18W	G24d-2	150	225	135-140	1,8		1310622	
EBDT 150/13 SM-EVG	1xTC-DEL/10,13W	G24q-1	150	225	135-140	1,6			1320609
EBDT 150/18 SM-EVG	1xTC-DEL/TEL/18W	G24q-2	150	225	135-140	1,6			1320622

